

FEATURED MODEL

440278 Large, 10" bowl depth

ADDITIONAL MODELS

440274 Large, 8" bowl depth

440276 Large, 12" bowl depth

FEATURES

- Required outside cabinet: 36"
- 18 gauge, 304 series stainless steel
- Premium 18/8 chrome/nickel content
- Satin Finish
- Sound deadening insulation
- 4 diagonal drain grooves channel water directly to center drain
- Straight bowl sides with 1-1/2" cutout corner radius

OPTIONAL ACCESSORIES

Stainless Steel Sink Grid: 220997

CODE/STANDARDS COMPLIANCE

ASME 112.19.3-00

IAPMO/UPC listed



NOMINAL DIMENSIONS

Model 440276 shown

OVERALL	CUT OUT SIZE	BOWL DEPTH	DRAIN
33" x 22"	32-1/4" x 21-1/4"	10"	3-1/2"

DXF cutout templates available on our website.

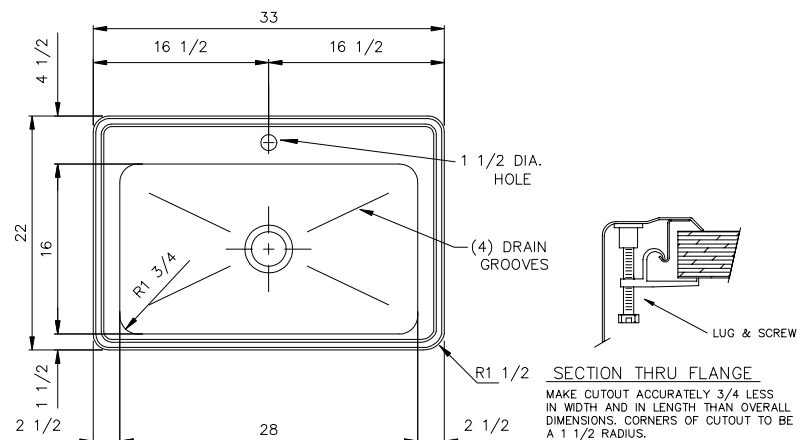

WARRANTY

Blanco America's Stainless Steel sinks feature a LIMITED LIFETIME WARRANTY to be free of all manufacturing defects under normal use. See our complete warranty for details.

While Blanco America endeavors to provide accurate information, all dimensions are nominal, cannot be guaranteed, and are subject to change or cancellation. Blanco America assumes no responsibility for use of superseded or voided specifications.

JOB INFORMATION

Job Name: _____

Contact: _____

Date Specified: _____

Specifier: _____

Contractor: _____

KNOCKOUT HOLE LOCATIONS

Pre-drilled for three faucet holes.

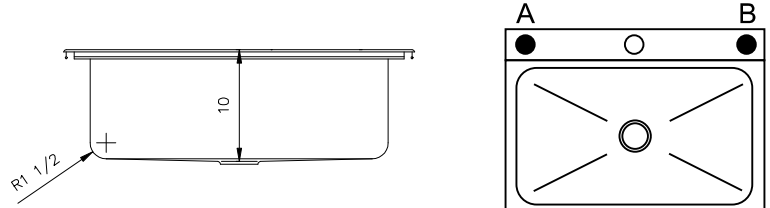

BLANCO AMERICA

800.451.5782

www.blancoamerica.com

© 2013 BLANCO AMERICA

7/13

SPEC-003